

ATIVIDADES ORIENTADORAS

EDUCAÇÃO INFANTIL

G6



SEMEEL

SECRETARIA MUNICIPAL DE
EDUCAÇÃO, ESPORTE E LAZER

A mudança está em nossas mãos

UNIDADE ESCOLAR:

PROFESSORA

GRUPO ETÁRIO

G6

CÓDIGO BNCC

EI03TS03

NOME:

HOJE É?

SEGUNDA

TERÇA

QUARTA

QUINTA

SEXTA

COMO ESTÁ O TEMPO HOJE?



DATA

/ /

VAMOS CANTAR PARA CONSCIENTIZAR

ERA UMA CASA

ERA UMA CASA

TÃO BEM CUIDADA

NÃO TINHA LIXO,

ÁGUA PARADA.

O TAL AEDES ALI NÃO VEM

POIS NÃO CONSEGUE

PICAR NINGUÉM.

NÃO TINHA FEBRE,

NEM DOR NOS OLHOS,

DOR DE CABEÇA OU

DOR NO CORPO.

SE TODO MUNDO

ENTÃO AJUDAR,

MUITOS SADIOS

VAMOS FICAR!

ENSAIE ESSA MÚSICA COM AS CRIANÇAS PARA QUE ELAS POSSAM APRESENTAR PARA OS ALUNOS DA ESCOLA.





UNIDADE ESCOLAR:

PROFESSORA

GRUPO ETÁRIO

G6

CÓDIGO BNCC

EI03EF08 EI03ET07

NOME:

HOJE É?

SEGUNDA

TERÇA

QUARTA

QUINTA

SEXTA

COMO ESTÁ O TEMPO HOJE?



DATA

/ /

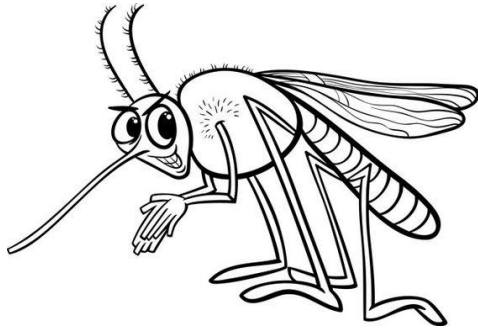

ESSE É O MOSQUITO AEDES AEGYPTI. ELE PODE NOS TRAZER UMA DOENÇA CHAMADA DENGUE. POR ISSO DEVEMOS ELIMINAR ESSE MOSQUITO.

PINTE NO ALFABETO AS LETRAS DA PALAVRA EM DESTAQUE:

DENGUE

A B C D E F G H I J
K L M N O P Q R S T
U V W X Y Z

QUANTAS LETRAS TEM A PALAVRA EM DESTAQUE? PINTE O NUMERAL CORRESPONDENTE:

1 2 3 4 5 6 7 8 9 10



UNIDADE ESCOLAR:

PROFESSORA

GRUPO ETÁRIO

G6

CÓDIGO BNCC

EI03ET04 EI03ET07

NOME:

HOJE É?

SEGUNDA

TERÇA

QUARTA

QUINTA

SEXTA

COMO ESTÁ O TEMPO HOJE?



DATA

/ /

VAMOS CONTAR?

DESENHE A QUANTIDADE DE MOSQUITOS QUE ESTÃO FALTANDO PARA COMPLETAR O AGRUPAMENTO DE ACORDO COM O NUMERAL INDICADO:

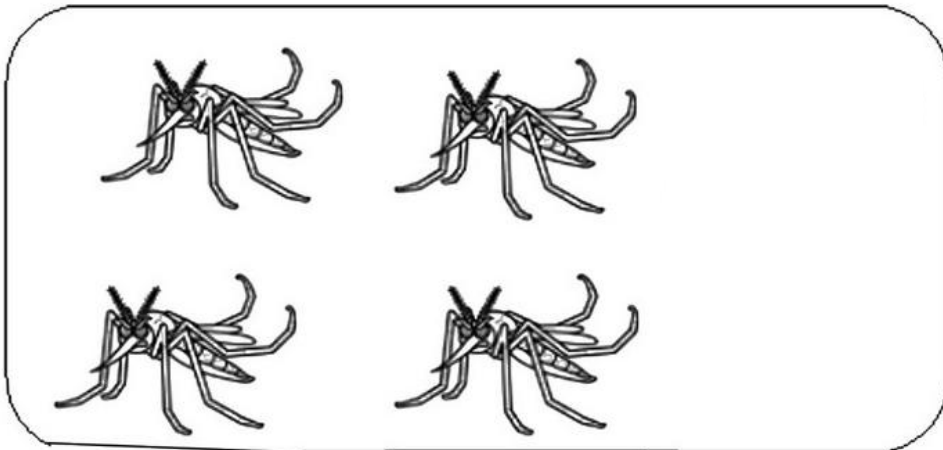

5

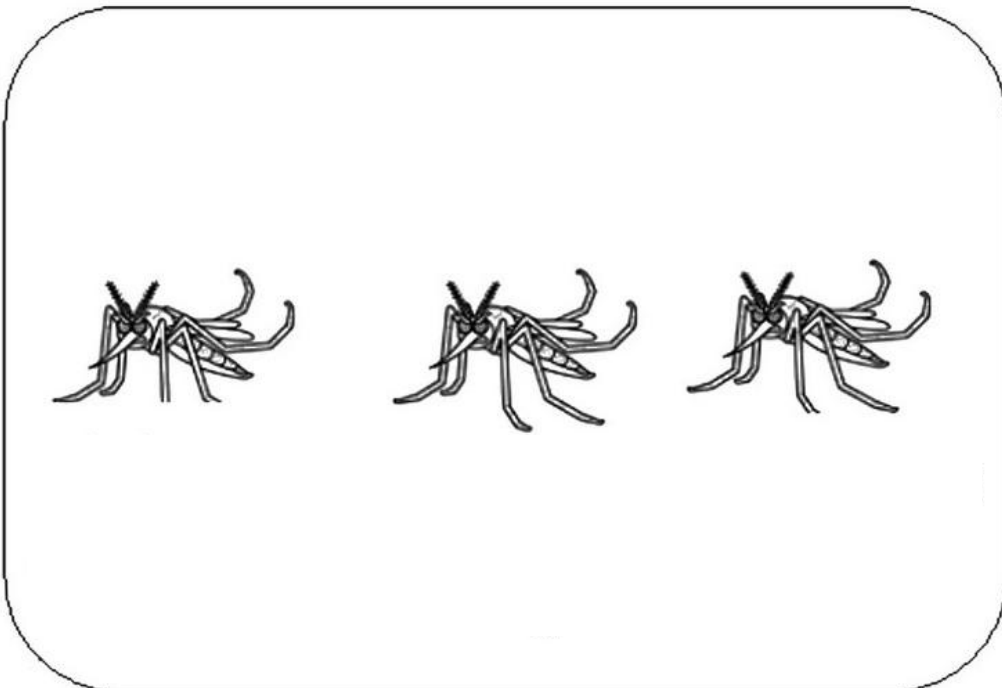

6

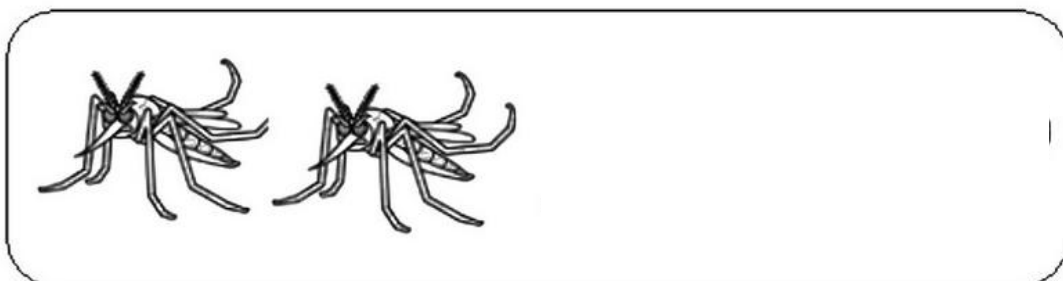

4

UNIDADE ESCOLAR:

PROFESSORA

GRUPO ETÁRIO

G6

CÓDIGO BNCC

EI03EF08 EI03EF09

NOME:

HOJE É?

SEGUNDA

TERÇA

QUARTA

QUINTA

SEXTA

COMO ESTÁ O TEMPO HOJE?



DATA

/ /

O COMBATE AO MOSQUITO DEPENDE DE TODOS NÓS!

MARQUE COM UM X AQUILO QUE DEVEMOS FAZER PARA EVITAR O NASCIMENTO DO MOSQUITO TRANSMISSOR DE DOENÇAS:

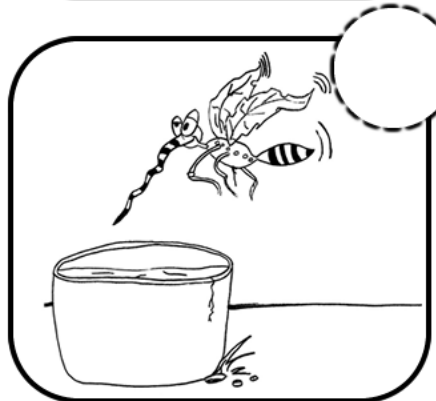
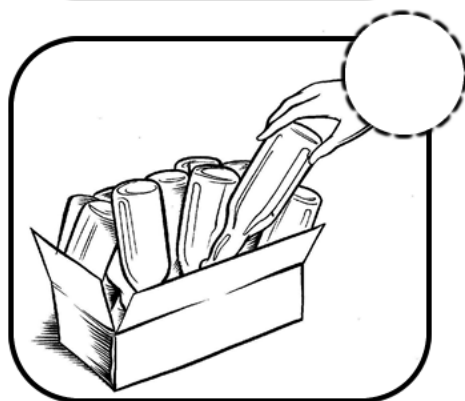
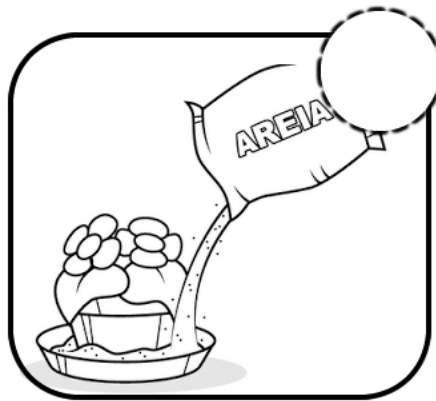
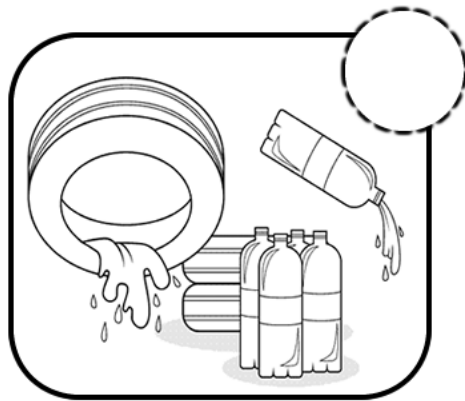

OBSERVE NO QUADRO ABAIXO OS NOMES DAS DOENÇAS QUE SÃO TRANSMITIDAS PELO MOSQUITO AEDES AEGYPTI E ESCREVA A LETRA INICIAL DE CADA UMA:

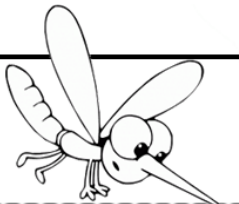

DENGUE	→		
ZIKA	→		
CHIKUNGUNYA	→		



UNIDADE ESCOLAR:

PROFESSORA

GRUPO ETÁRIO

CÓDIGO BNCC

NOME:

HOJE É?

SEGUNDA

TERÇA

QUARTA

QUINTA

SEXTA

COMO ESTÁ O TEMPO HOJE?



DATA

JOGO DOS 3 ERROS

ENCONTRE OS 3 ERROS E MARQUE COM X:

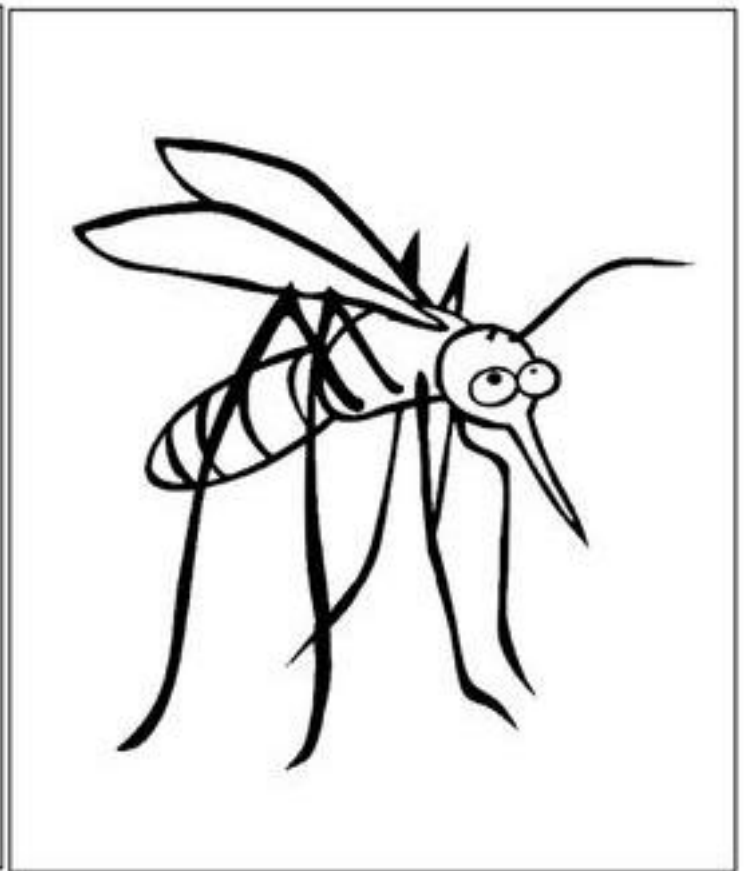
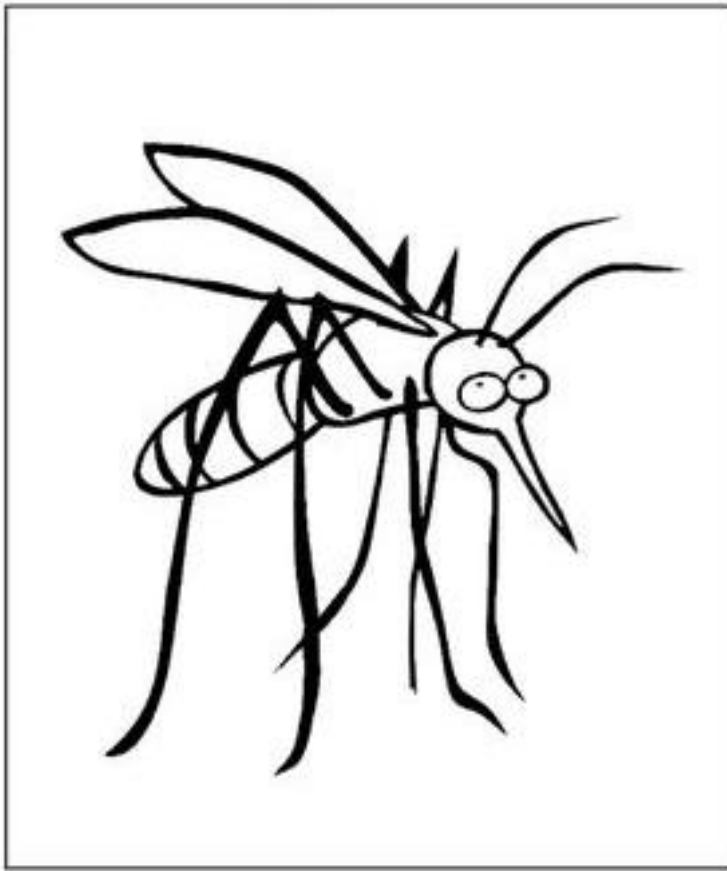

QUANTOS ERROS VOCÊ ENCONTROU? REGISTRE O ESSE NUMERAL COMO SOUBER: